

Programmable AC & DC Electronic load

MODEL 63800 SERIES

Key Features

- Power Rating :
1800W, 3600W, 4500W
- Voltage Range :
50V ~ 350Vrms
- Current Range :
Up to 18Arms, 36Arms, 45Arms
- Peak Current :
Up to 54A, 108A, 135A
- Parallel / 3-Phase Function
- Frequency Range :
45 ~ 440Hz, DC
- Crest Factor Range :
1.414 ~ 5.0
- Power Factor Range :
0 ~ 1 lead or lag (Rectified mode)
- CC, CR, CV, CP for DC Loading
- Constant & Rectified Load Modes
for AC Loading
- Analog Voltage & Current Monitor
- Timing Measurement for Battery,
UPS, Fuse and Breaker tests
- Measurement :
V, I, PF, CF, P, Q, S, F, R, Ip+/- and THDv
- Short circuit simulation
- Full Protection :
OP, OC, OT protection and OV alarm
- GPIB & RS-232 interfaces



PROGRAMMABLE AC & DC ELECTRONIC LOAD MODEL 63800 SERIES

Chroma's 63800 Series AC&DC Electronic Loads are designed for testing Uninterruptible Power Supplies(UPS), Off-Grid Inverters, AC sources and other power devices such as switches, circuit breakers, fuses and connectors.

The Chroma 63800 Loads can simulate load conditions under high crest factor and varying power factors with real time compensation even when the voltage waveform is distorted. This special feature provides real world simulation capability and prevents over-stressing thereby gives reliable and unbiased test results.

The 63800's state of the art design uses DSP technology to simulate non-linear rectified loads with its unique RLC operation mode. This mode improves stability by detecting the impedance

of the UUT and dynamically adjusting the load's control bandwidth to ensure the system's stability.

Comprehensive measurements allow users to monitor the output performance of the UUT. Additionally, voltage & current signals can be routed to an oscilloscope through analog outputs. The GPIB/RS232 interface options provide remote control & monitor for system integration. The built-in digital outputs may also be used to control the external relays for short circuit (crowbar) testing.

Chroma's 63800 Loads feature in fan speed control to ensure low acoustic noise. The diagnosis/protection functions include self-diagnosis routines and protection against over-power, over-current, over-temperature and over-voltage alarm.



Chroma

Complete AC & DC Load Simulations

Chroma's 63800 AC/DC Electronic Load is designed for both AC & DC Load Simulations. Illustrated below are the various load modes which are available:

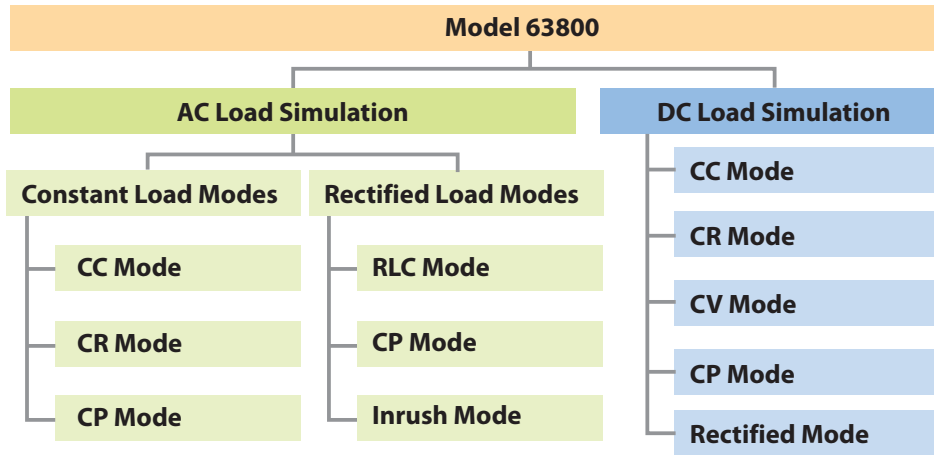

AC Load Simulation

The Model 63800 AC/DC Electronic Load provides two unique operating modes for AC load simulation; (1) Constant Load Modes and (2) Rectified AC Load Modes. Each are described below.

Constant Load Modes

The Constant Load Modes allow users to set the following operating modes : CC, CR and CP mode. The CC & CP modes in this category allow users to program PF or CF, or both. For CR mode the PF is always set to 1.

When both the PF & CF of the loading current are programmed, the 63800 load controls power factor from 1 to 0 by shifting the current (with CF defined) relative to the input voltage to get the desired displacement power factor. The power factor range is limited based on the crest factor programmed. If the programmed PF is positive then the current will lead the voltage waveform and when PF is set negative, the current will lag the voltage waveform. (See below)

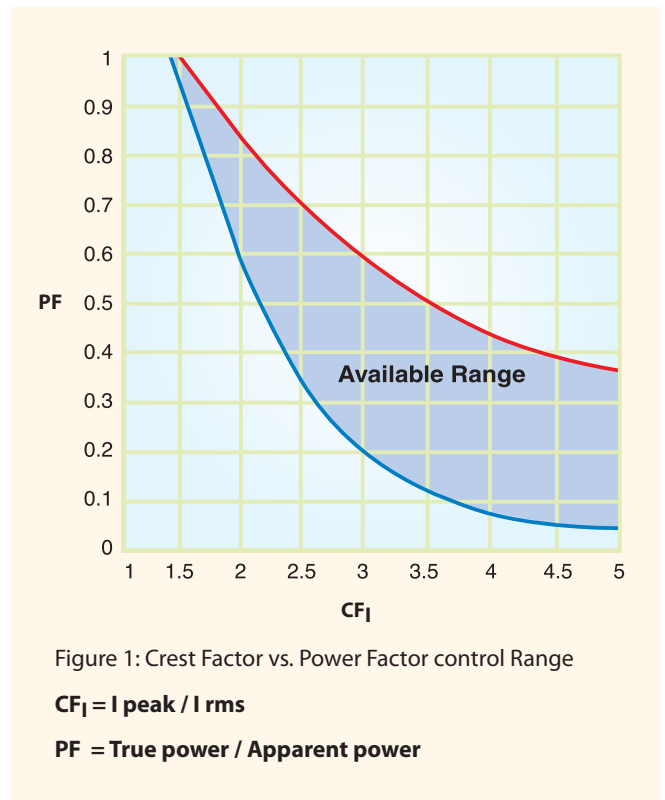
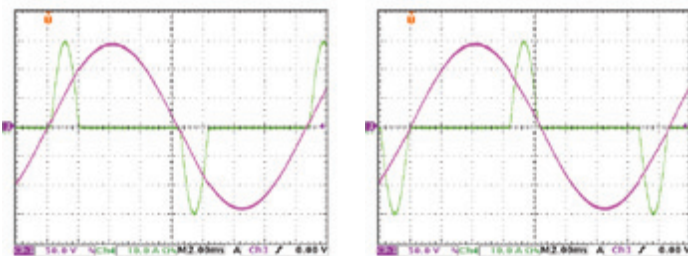

As seen in Figure 1, for a crest factor of 1.414, the programmed power factor can only be 1 if the input voltage is a sine-wave. However, for a CF of 2.0, the acceptable PF ranges from 0.608 to 0.85; for CF = 3, the PF can then be set from 0.211 to 0.6, etc. So, higher crest factors enable a wider range of power factors.

Rectified AC Load Modes

The 63800 AC/DC Electronic Load provides unique capability to simulate non-linear rectified loads for a wide range of testing applications. There are three load modes available for rectified load simulations : RLC, CP and Inrush Current.

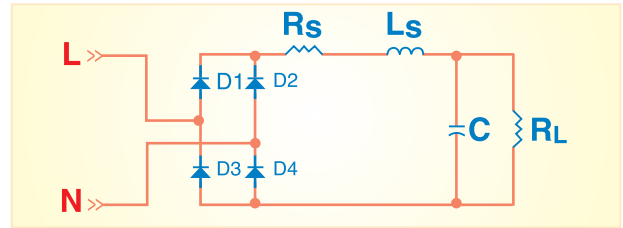

Figure 2 : Typical Rectified Circuit

Figure 2 shows the typical model of a rectifier input. Under RLC mode, users can set the RLC values to 100% and simulate the behavior of the actual UUT. Figure 3 & 4 compares the voltage and loading waveforms between the actual RLC built circuit and the simulated rectified circuit using Chroma's RLC load mode. The waveform of the 63800 in RLC mode looks almost identical to the waveform of the actual hardware circuit. The waveform obtained under CC mode with the same loading crest factor shown in Figure 5 is considerably different than the waveform of actual hardware circuit.

In addition, traditional AC loads can only use CR mode to test discontinuous square or quasi-square wave UUTs because CC and CP are all active loadings, which require a defined frequency. It's very difficult to detect the frequency of a discontinuous square or quasi-square wave. The RLC mode of the 63800 load is actually simulating passive loading and it doesn't require a defined frequency, therefore it allows the user to simulate loading in modes other than just CR. Using a discrete RLC network may solve the problem; however, the component weight, size and limited RLC values make it inconvenient for testing. In contrast, Chroma's 63800 RLC mode is much more flexible and provides a complete host of settings.

For production line testing, most users may not know the required RLC values but do know the UUTs power rating and PF values. In this case, the CP mode is ideal for test engineers. Under CP mode, the 63800 built-in algorithm will find the best way to get the RLC values automatically according to the power rating and PF value set by the user.

To avoid overstressing the UUT, both RLC and CP modes will gradually increase the load current up to the programmed loading current shown in Figure 4, simulating actual RLC circuit loading as shown in Figure 3. This will alleviate the sudden voltage drop from the constant current loading mode as shown in Figure 5.

For inrush current simulation, the 63800 provides an Inrush Current mode that allows the user to set different inrush current amplitude and voltage phase angle where the inrush current started.

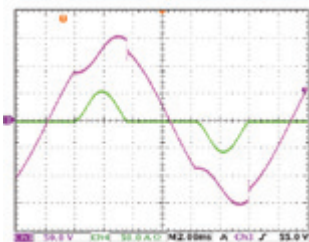

Figure 3: Actual RLC Circuit

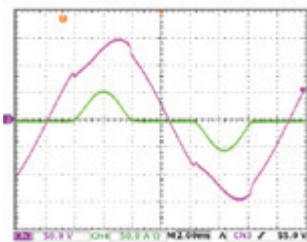

Figure 4: Simulated RLC Mode

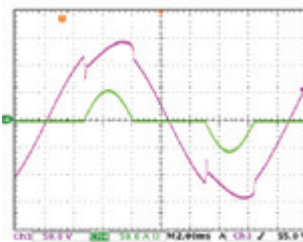

Figure 5: CC Mode

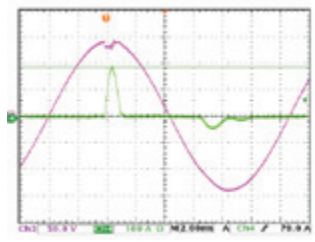
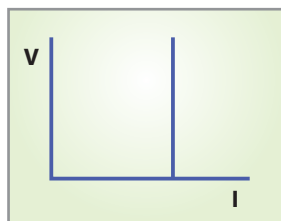

Figure 6: Inrush Current Mode

DC Load Simulation

Chroma's 63800 DC load simulation includes four load modes : constant current, constant resistance, constant voltage and constant power as depicted below.



Constant current

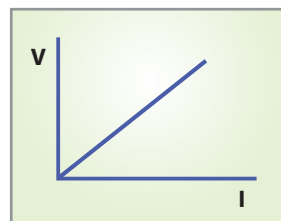

Constant resistance

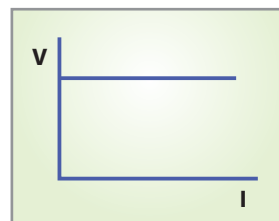

Constant voltage

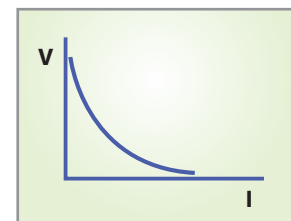

Constant power

CC, CR, CP mode can be used for regulated voltage power supply testing. For battery charger, CV mode may help to check its current regulation. A special DC Rectified mode is included to simulate the loading behavior of distributed inverters. Many inverter designs, although its input is DC, show an input current and will show rectified pattern. This unique load mode makes the Chroma 63800 load ideal for Fuel Cell, PV module/array and Battery testing.

Comprehensive Measurements

Chroma's 63800 Series AC/DC Electronic Loads include built-in 16-bits precision measurement circuits to measure the steady-state and transient responses for true RMS voltage, true RMS current, true power(P), apparent power(S), reactive power(Q), crest factor, power factor, THDv and peak repetitive current.

In addition to these discrete measurements, two analog outputs, one for voltage and one for current, are provided as a convenient means of monitoring these signals via an external oscilloscope.

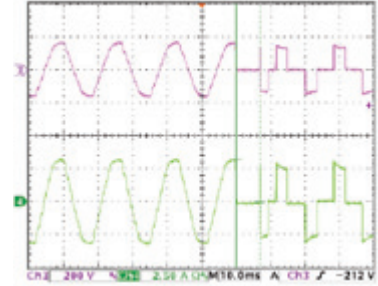

Figure 7 : Transfer time for Off-Line UPS

Timing Measurement

Timing parameters are critical to many products such as UPS's Breakers and Fuses. The 63800 AC/DC Load also includes a unique timing and measurement function to measure the trip time of fuses & circuit breakers or the transfer time for UPS's (Off-Line).

Automatic Bandwidth Adjustment (ABA)

When using active load mode (CC, CP), traditional AC loads operate under fixed bandwidth. When the load is working at low control bandwidth it will limit the load from simulating high crest factor loading. Conversely, increased control bandwidth will influence the control loop stability especially when the UUT output impedance is high. To resolve this problem of traditional AC loads, the Chroma 63800 AC/DC Load dynamically adjusts the operating bandwidth by detecting the impedance*1 of the UUTs to alleviating the risk of system instability.

The examples on the right compare voltage and current waveforms using a traditional fixed bandwidth (@15kHz) load and the Chroma 63800 load for UPS load simulation. A significant difference can be observed with and without the ABA.

When the UUT, such as one shown in Figure 8, has a higher output impedance, the current waveform will not be stable without ABA. In most cases, the loading current will be oscillating and spoil the test.

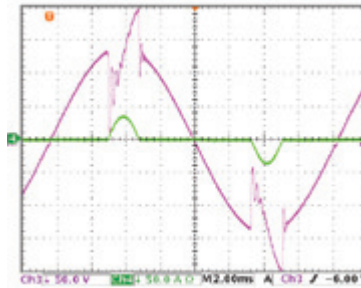

Figure 8: Fixed Bandwidth

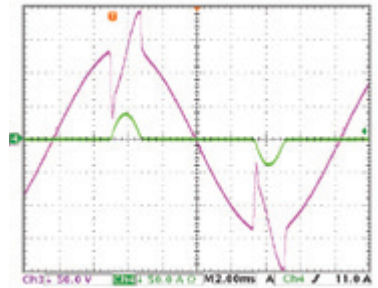

Figure 9: With ABA

Note 1 : A test current will be programmed prior the actual loading defined by user for impedance detection.

Parallel / 3-Phase Control

The 63800 series provides parallel and 3-phase functions for high power and three phase applications. All the models within the 63800 series can be used together for both parallel and 3-phase functions as well as paralleled AC Load units in a 3-phase configuration, providing excellent flexibility and cost savings for the 63800 series AC load. Parallel and 3-phase controls are made easy by linking the AC Load units together and control of all AC load units is performed through the Master Unit. Connections of parallel and 3-phase functions are shown in Figures 10, 11 and 12.

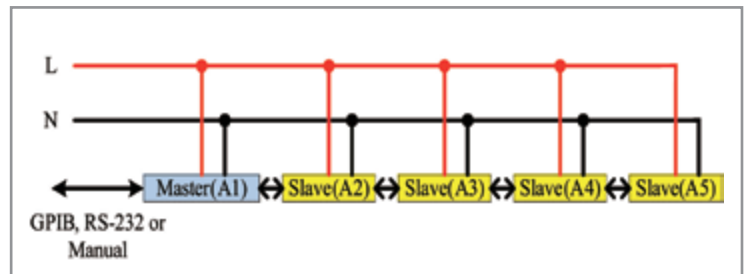

Figure 10: Parallel connection

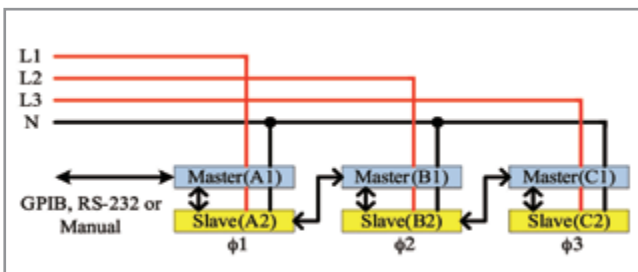

Figure 11: Parallel/3-Phase Y connection

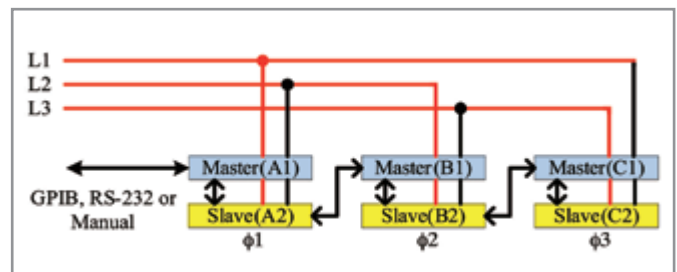

Figure 12: Parallel/3-Phase Delta connection

Auto Power Factor Correction

Setting the power factor is one of the major features to the 63800. The power factor is defined as :

$$PF = \frac{P_{\text{active}}}{V_{\text{rms}} \cdot I_{\text{rms}}} = \frac{\frac{1}{T} \int_0^T v(t) \cdot i(t) dt}{\sqrt{\frac{1}{T} \int_0^T v^2(t) dt} \cdot \sqrt{\frac{1}{T} \int_0^T i^2(t) dt}}$$

Since PF is a function of real time voltage and current, traditional AC load designs assume the voltage waveform to be sinusoidal all the time, as seen Figure 13. This is not realistic because the voltage waveform may be distorted after the load is applied shown in Figure 14. If the control of power factor is based on the assumption that the voltage waveform is sinusoidal, it will result in a lower power factor than the user programmed, thus overstressing the UUT. Chroma's 63800 AC loads monitor the power factor reading constantly and use this data to dynamically adjust the loading waveform. As a result, the power factor setting is precise and does not overstress the UUT.

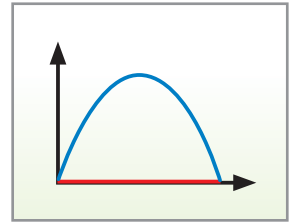

Figure 13

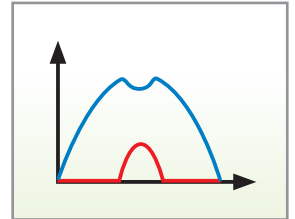
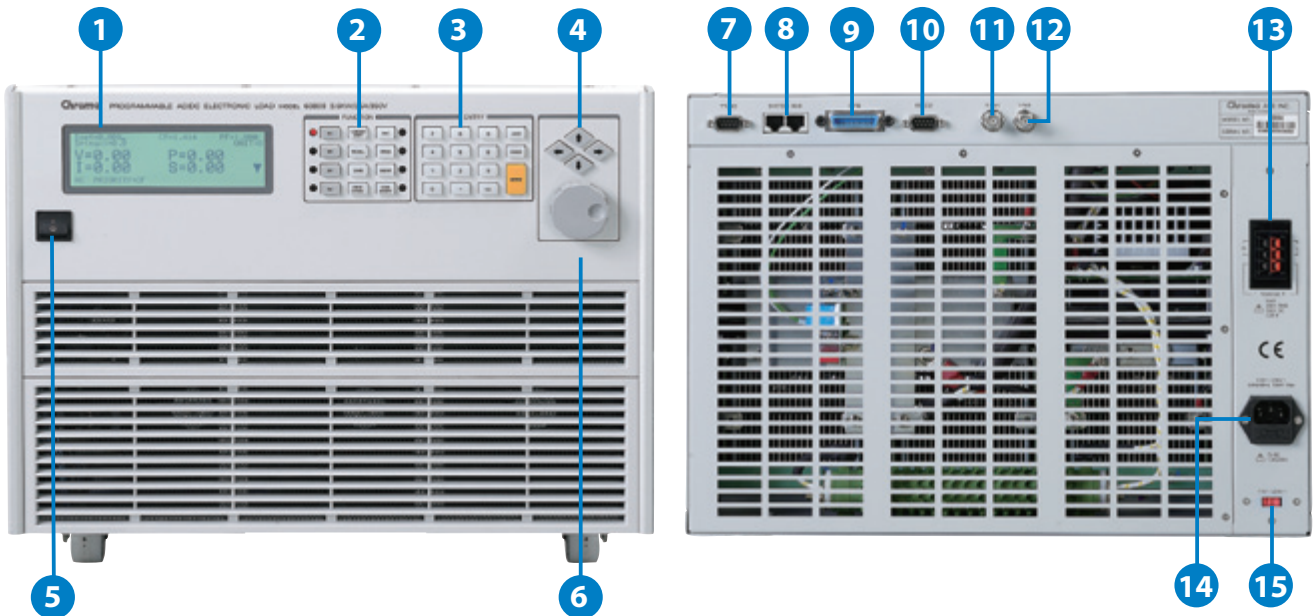

Figure 14

PANEL DESCRIPTION



1. LCD display

2. Function keypad

To select load mode, control mode, and system config setting

3. Numeric keypad

For data setting

4. Cursor key

For setting and editing

5. Power switch

6. Rotary knob

For rapid control of active parameter

7. TTL I/O

For system input/output control signal (Load ON/OFF, Transient ON/OFF, Fail, Short, External Load ON/OFF)

8. System bus

For master/slave control system data communication

9. GPIB connector

10. RS-232 connector

11. Voltage monitor output

Analog output proportional to voltage waveform

12. Current monitor output

Analog output proportional to the current waveform

13. Load terminal & Voltage sense terminal

14. AC input connector

15. AC input voltage switch

ORDERING INFORMATION

63802 : Programmable AC&DC Electronic Load 1800W/18A/350V

63803 : Programmable AC&DC Electronic Load 3600W/36A/350V

63804 : Programmable AC&DC Electronic Load 4500W/45A/350V



63802

SPECIFICATIONS

Model	63802	63803	63804
Power	1800W	3600W	4500W
Current	0 ~ 18Arms (54 Apeak, continue)	0 ~ 36Arms (108 Apeak, continue)	0 ~ 45Arms (135 Apeak, continue)
Voltage*1	50 ~ 350Vrms (500 Vpeak)	50 ~ 350Vrms (500 Vpeak)	50 ~ 350Vrms (500 Vpeak)
Frequency	45 ~ 440Hz, DC	45 ~ 440Hz, DC	45 ~ 440Hz, DC
AC Section			
Constant Current Mode			
Range	0 ~ 18Arms, Programmable	0 ~ 36Arms, Programmable	0 ~ 45Arms, Programmable
Accuracy	0.1% + 0.2%F.S.	0.1% + 0.2%F.S.	0.1% + 0.2%F.S.
Resloution	2mA	5mA	5mA
Constant Resistance Mode			
Range	2.77Ω ~ 2.5kΩ, Programmable	1.39Ω ~ 2.5kΩ, Programmable	1.11Ω ~ 2.5kΩ, Programmable
Accuracy	0.5% + 0.5%F.S.	0.5% + 0.5%F.S.	0.5% + 0.5%F.S.
Resloution*2	20μS	50μS	50μS
Constant Power Mode			
Range	1800W, Programmable	3600W, Programmable	4500W, Programmable
Accuracy	0.5% + 0.5%F.S.	0.2% + 0.3%F.S.	0.2% + 0.3%F.S.
Resloution	0.375W	1.125W	1.125W
Crest Factor (under CC, CP modes)			
Range	1.414 ~ 5.0, Programmable	1.414 ~ 5.0, Programmable	1.414 ~ 5.0, Programmable
Accuracy	(0.5% / Irms) + 1% F.S.	(0.5% / Irms) + 1%F.S.	(0.5% / Irms) + 1%F.S.
Resloution	0.005	0.005	0.005
Power Factor			
Range	0 ~ 1 lead or lag, Programmable	0 ~ 1 lead or lag, Programmable	0 ~ 1 lead or lag, Programmable
Accuracy	1%F.S.	1%F.S.	1%F.S.
Resloution	0.001	0.001	0.001
Rectified Load Mode			
Operating Frequency	45Hz ~ 70Hz		
RLC Mode	Parameter : Ip(max), R _s , L _s , C, R _L		
Constant Power Mode	Parameter : Ip(max), Power setting=200W ~ 1800W, PF=0.4 ~ 0.75	Parameter : Ip(max), Power setting=200W ~ 3600W, PF=0.4 ~ 0.75	Parameter : Ip(max), Power setting=200W ~ 4500W, PF=0.4 ~ 0.75
Inrush Current Mode	Parameter : Ip(max), R _s , L _s , C, R _L , Phase		
	80A (peak current)	160A (peak current)	200A (peak current)
R_s Range	0 ~ 9.999Ω	0 ~ 9.999Ω	0 ~ 9.999Ω
L_s Range	0 ~ 9999μH	0 ~ 9999μH	0 ~ 9999μH
C Range	100 ~ 9999μF	100 ~ 9999μF	100 ~ 9999μF
R_L Range	2.77 ~ 9999.99Ω	1.39 ~ 9999.99Ω	1.11 ~ 9999.99Ω
DC Section			
Voltage Range	7.5V ~ 500V	7.5V ~ 500V	7.5V ~ 500V
Current Range	0A ~ 18A	0A ~ 36A	0A ~ 45A
Min. operating voltage	7.5V	7.5V	7.5V
Rise time	75μs	75μs	75μs
Operating Mode	CC, CV, CR, CP, DC Rectified		
Short Circuit Simulation	Use the CR mode loading under max. power rating		
Measurement Section			
DVM Range	350V _{rms} (500V _{peak})	350V _{rms} (500V _{peak})	350V _{rms} (500V _{peak})
DVM Accuracy	0.1% + 0.1%F.S.	0.1% + 0.1%F.S.	0.1% + 0.1%F.S.
DVM Resloution	10mV	10mV	10mV
DAM Range	18A _{rms} (80A _{peak})	36A _{rms} (160A _{peak})	45A _{rms} (200A _{peak})
DAM Accuracy(<70Hz)	0.1% + 0.2%F.S.	0.1% + 0.2%F.S.	0.1% + 0.2%F.S.
DAM Accuracy(>70Hz)	0.1% (1+CF ² x kHz)+0.2% F.S.	0.1% (1+CF ² x kHz)+0.2% F.S.	0.1% (1+CF ² x kHz)+0.2% F.S.
DAM Resloution	1.0mA	1.0mA	1.0mA
Other Parameter	P(W), S(VA), Q(VAR), CF, PF, Freq, R, Ip-, Ip+, THDv		
Others			
Vmonitor	± 500V / ± 10V (Isolated)	± 500V / ± 10V (Isolated)	± 500V / ± 10V (Isolated)
Imonitor	± 80A / ± 10V (Isolated)	± 200A / ± 10V (Isolated)	± 200A / ± 10V (Isolated)
Protection	OCP : 19.2Arms ; OV alarm: 360Vrms (DC : 510VDC) OPP : 1920W ; OTP	OCP : 38.4Arms ; OV alarm: 360Vrms (DC : 510VDC) OPP : 3840W ; OTP	OCP : 48Arms ; OV alarm: 360Vrms (DC : 510VDC) OPP : 4800W ; OTP
Remote Interface	GPIB, RS-232		
Input Rating	1Ø 100~115Vac ± 10% V _{LNR} 47~63Hz; 1Ø 200~230Vac ± 10% V _{LNR} 47~63Hz		
Dimension (H x W x D)	177 x 440 x 595 mm / 7.0 x 17.32 x 23.42 inch	310 x 440 x 595 mm / 12.2 x 17.32 x 23.42 inch	310 x 440 x 595 mm / 12.2 x 17.32 x 23.42 inch
Weight	37kg / 81.57 lbs	66 kg / 145.5 lbs	66 kg / 145.5 lbs

NOTE*1 : If the operating voltage exceeds the rated voltage for 1.1 times, it would cause permanent damage to the device.

NOTE*2 : S (siemens) is the SI unit of conductance, equal to one reciprocal ohm.

* All specifications are subject to change without notice. Please visit our website for the most up to date specifications.

Developed and Manufactured by :

CHROMA ATE INC.
HEADQUARTERS

66 Hwaya 1st Rd., Kueishan
Hwaya Technology Park,
Taoyuan County 33383,
Taiwan
Tel: +886-3-327-9999
Fax: +886-3-327-8898
http://www.chromaate.com
E-mail: info@chromaate.com

CHINA

**CHROMA ELECTRONICS
(SHENZHEN) CO., LTD.**
8F, No.4, Nanyou Tian An
Industrial Estate, Shenzhen,
China PC: 518052
Tel: +86-755-2664-4598
Fax: +86-755-2641-9620

JAPAN

CHROMA JAPAN CORP.
472 Nippa-cho, Kouhoku-ku,
Yokohama-shi, Kanagawa,
223-0057 Japan
Tel: +81-45-542-1118
Fax: +81-45-542-1080
http://www.chroma.co.jp
E-mail: info@chromaate.com

U.S.A.

**CHROMA SYSTEMS
SOLUTIONS, INC.**
19772 Pauling,
Foothill Ranch, CA 92610
Tel: +1-949-600-6400
Fax: +1-949-600-6401
http://www.chromausa.com
E-mail: sales@chromausa.com

EUROPE

CHROMA ATE EUROPE B.V.
Morsestraat 32, 6716 AH Ede,
The Netherlands
Tel: +31-318-648282
Fax: +31-318-648288
http://www.chroma.eu.com
E-mail: sales@chroma.eu.com

Worldwide Distribution and
Service Network